

CTR-146 (8299) CAT6 TELEPHONE-DATA TERMINAL SOCKET. 1 PORT WITH DUST COVER

Package contents:

- 1 CAT6 1 port terminal rosette
- 2 Screw anchors+1 adhesive for wall mounting
- 1 Nylon cable tie

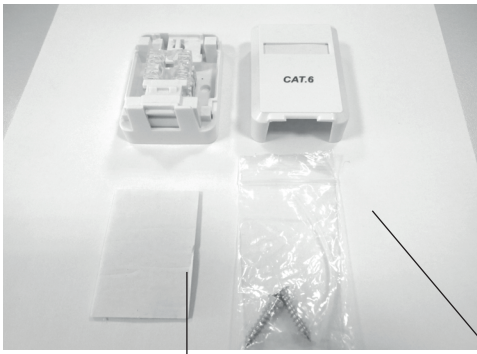

To open, insert a screwdriver into the slot

RJ45 connector input

Power strip protector
Cable gland hole for cable fixing

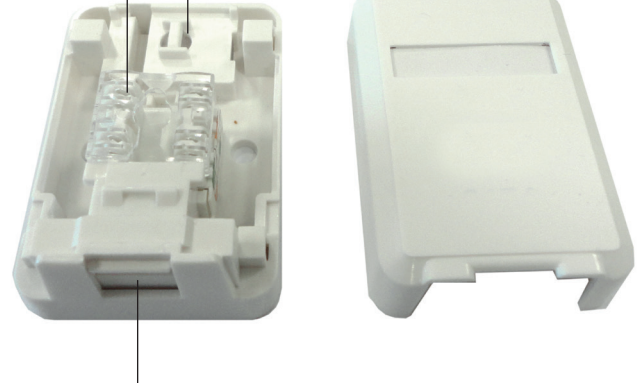

Self-closing dust cover

CONNECTION THE CABLES TO THE TERMINAL

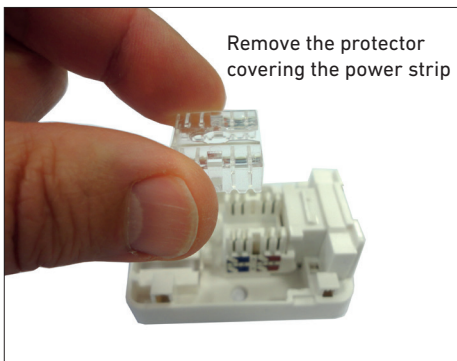

Remove the protector covering the power strip

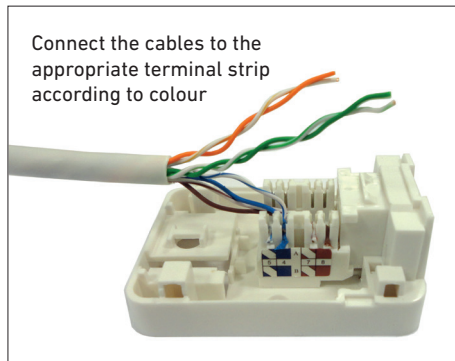

Connect the cables to the appropriate terminal strip according to colour

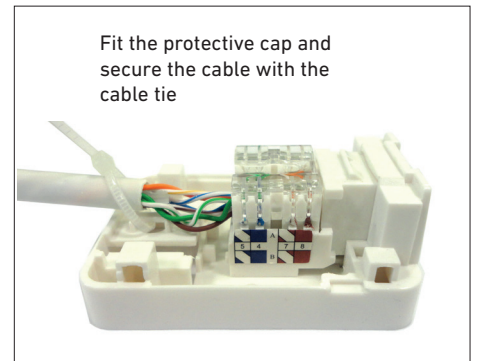

Fit the protective cap and secure the cable with the cable tie

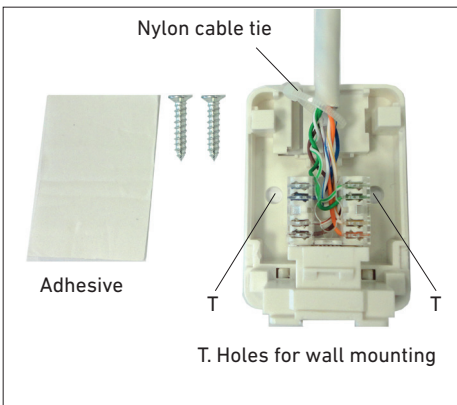

Nylon cable tie

Adhesive

T

T. Holes for wall mounting

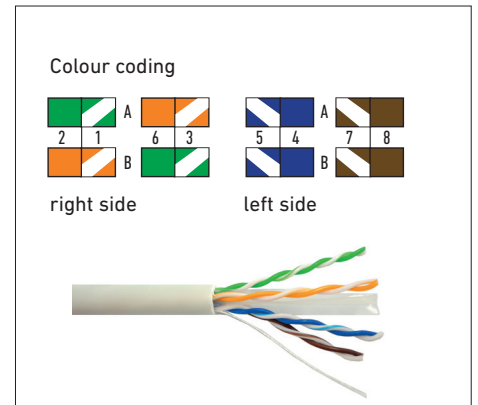

Colour coding

	A		6		A		7
	2		1		B		8
	B		3		A		4
	5		4		B		8

right side

left side

